

TRAUMA SYSTEM TITANIUM



 **IMAGE**[®]
ORTHO. SURGICAL PVT. LTD.
An ISO 13485 Certified Company

www.imageorthosurgical.com

Excellent Quality with Best Service...

INTRODUCTION

IMAGE Ortho Surgical incorporates a business concept of developing & marketing of orthopedic implants & instrument in whole country since 1995.

IMAGE have quality management system approved by international standard organization. We qualified with all the international quality standard like mfg. FDA, ISO 13485, CE & ISO 9001 certificate.

Quality has main characteristic for success of **IMAGE** Product. Each every product developing & marketing by as under goes meticulous quality surveillance with required documentation. To be able to meet the need of verities of ortho implants. We offer you a worldwide range of orthopedics product like Lock Plate, Lock Screw, Spine Implant, Bone Plate, Bone Screw, Interlocking Nail, Hip Prosthesis, Ilizarov & many more.

We committed to total customer satisfaction by providing “Excellent Quality with Best Service”. As well as we maintain our position as a leading reliable supplier in whole country.

We always ready to supply the best quality product as per the day to day market requirement. As well as our marketing representative who also get the feed back of customer on product & service.

CERTIFICATION



BONE SCREW

CORTICAL SCREW (Hex.) 2.7 mm - Self Tapping
CAT NO. 1201



Size : 10 mm to 30 mm with 2 mm Variation

CORTICAL SCREW (Hex.) 3.5 mm - Self Tapping
CAT NO. 1202



Size : 10 mm to 50 mm with 2 mm Variation
55 mm & 60 mm with 5 mm Variation

CORTICAL SCREW (Hex.) 4.5 mm - Self Tapping
CAT NO. 1203



Size : 20 mm to 50 mm with 2 mm Variation
55 mm to 70 mm with 5 mm Variation

**CANNULATED CANCELLOUS SCREW (Hex.)
(4 mm x 16 mm Thread) Self Tapping**
CAT NO. 1204



Size : 10 mm to 80 mm with 5 mm Variation

**CANNULATED CANCELLOUS SCREW (Hex.)
(4 mm x Full Thread) Self Tapping**
CAT No. 1205



Size : 25 mm to 80 mm with 5 mm Variation

**CANNULATED CANCELLOUS SCREW (Hex.)
(6.5 mm x 16 mm Thread) Self Tapping**
CAT No. 1206



Size : 30 mm to 120 mm with 5 mm Variation

**CANNULATED CANCELLOUS SCREW (Hex.)
(6.5 mm x 32 mm Thread) Self Tapping**
CAT No. 1207



Size : 40 mm to 120 mm with 5 mm Variation

**CANNULATED CANCELLOUS SCREW (Hex.)
(6.5 mm x Full Thread) Self Tapping**
CAT No. 1208



Size : 35 mm to 100 mm with 5 mm Variation

INTERLOCKING BOLT (HEX.) 3.4 mm
CAT No. 1209



Size : 20 mm to 40 mm with 2 mm Variation
45 mm & 50 mm with 5 mm Variation

INTERLOCKING BOLT (Hex.) 3.9 mm
CAT No. 1210



Size : 22 mm to 50 mm with 2 mm Variation
55 mm & 60 mm with 5 mm Variation

INTERLOCKING BOLT (HEX.) 4.9 mm
CAT No. 1211



Size : 24 mm to 50 mm with 2 mm Variation
55 mm to 80 mm with 5 mm Variation

D. H. SCREW
CAT No. 1212

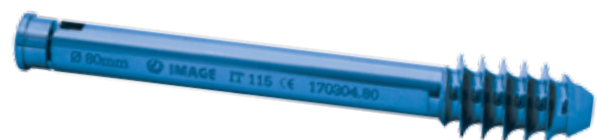

Size : 50 mm to 100 mm with 5 mm Variation

BONE SCREW

HERBERT SCREW

CAT No. 1213



Size : 12 mm to 40 mm at 2 mm Variation
45 mm to 70 mm at 5 mm Variation

A. P. F. NAIL BLADE

CAT No. 1216



Size : 70 mm to 120 mm with 5 mm Variation

P. F. N. BOLT (Hex.) 6.4 mm x Cannulated - Self Tapping

CAT No. 1214



Size : 50 mm to 120 mm with 5 mm Variation

MALLEOLAR SCREW (4.5 mm x Hex.)

CAT No. 1217



Size : 25 mm to 80 mm with 5 mm Variation

P. F. N. BOLT (Hex.) 8.0 mm x Cannulated - Self Tapping

CAT No. 1215



Size : 50 mm to 120 mm with 5 mm Variation

CANCELLOUS SCREW (6.5 mm x F.T.)

CAT No. 1218



Size : 40 mm to 100 mm with 5 mm Variation

BONE PLATE

D. C. PLATE (3.5 mm x R/U)

CAT No. 1301



Size : 4 Hole to 12 Hole
Fixation with 3.5 mm Cortical Screw

8 PLATE

CAT No. 1304



Size : 20 mm, 25 mm, 30 mm

D. C. PLATE (4.5 mm x Narrow)

CAT No. 1302



Size : 5 Hole to 16 Hole
Fixation with 4.5 mm Cortical Screw

L.C.D.C. PLATE (3.5 mm x R/U)

CAT No. 1305



Size : 5 Hole to 12 Hole
Fixation with 3.5 mm Cortical Screw

D. H. S. PLATE (D.C. HOLE) 135°

CAT No. 1303



Size : 4 Hole to 8 Hole
Fixation with 4.5 mm Cortical Screw

LOCK. SCREW

LOCK. CORTICAL SCREW (2.7 mm x Hex.)
CAT No. 1401 Self Tapping



Size : 12 mm to 40 mm with 2 mm Variation

LOCK. CANCELLOUS SCREW (5.0 mm x Full Thread)
CAT No. 1405 Self Tapping



Size : 25 mm to 90 mm with 5 mm Variation

LOCK. CORTICAL SCREW (3.5 mm x Hex.)
CAT No. 1402 Self Tapping



Size : 12 mm to 60 mm with 2 mm Variation

WIRE MOUNT
CAT No. 1407



Size : 3.5 mm & 5 mm

LOCK. CORTICAL SCREW (5.0 mm x Hex.)
CAT No. 1403 Self Tapping



Size : 18 mm to 100 mm with 2 mm Variation

LOCK. CORTICAL SCREW (2.7 mm x Star)
CAT No. 1408



Size : 10 mm to 40 mm with 2 mm Variation

LOCK. CANCELLOUS SCREW (3.5 mm x Full Thread)
CAT No. 1404 Self Tapping

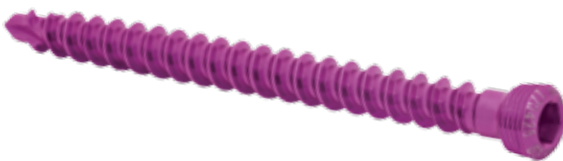

Size : 10 mm to 85 mm with 5 mm Variation

LOCK. PLATE

LOCK. D.C. PLATE (3.5 mm x R/U)
CAT No. 1500

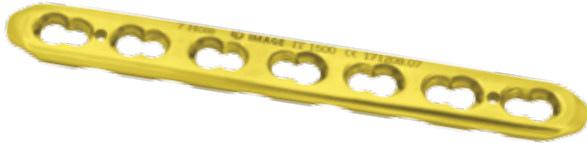

Size : 5 Hole to 12 Hole
Fixation with 3.5 mm Lock. Screw

LOCK. PHILOS PLATE
CAT No. 1505



Size : 3 Hole to 12 Hole
Fixation with 3.5 mm Lock. Screw

LOCK. D.C. PLATE (4.5 mm x Broad)
CAT No. 1501

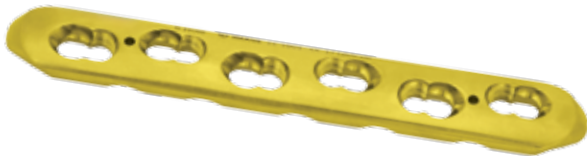

Size : 6 Hole to 16 Hole
Fixation with 5.0 mm Lock. Screw

LOCK. RECONSTRUCTION PLATE (3.5 mm)
CAT No. 1506



Size : 4 Hole to 16 Hole
Fixation with 3.5 mm Lock. Screw

LOCK. D.C. PLATE (4.5 mm x Narrow)
CAT No. 1502

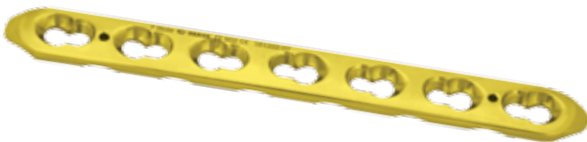

Size : 6 Hole to 14 Hole
Fixation with 5.0 mm Lock. Screw

LOCK. D.H.S. PLATE (130° & 135°)
CAT No. 1507



Size : 4 Hole to 8 Hole
Fixation with 5.0 mm Lock. Screw

LOCK. DISTAL FEMUR PLATE (LEFT & RIGHT)
CAT No. 1503

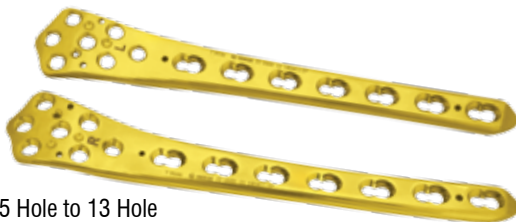

Size : 5 Hole to 13 Hole
Fixation with 5.0 mm Lock. Screw

LOCK. DISTAL MEDIAL TIBIA PLATE (LEFT & RIGHT)
CAT No. 1508

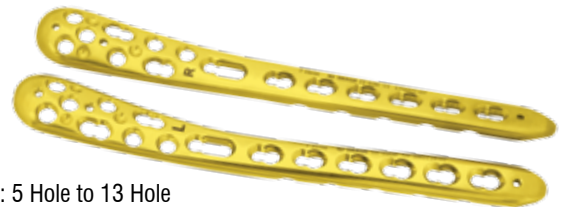

Size : 5 Hole to 13 Hole
Fixation with 3.5 mm Lock. Screw

LOCK. LATERAL TIBIA PLATE (LEFT & RIGHT)
CAT No. 1504

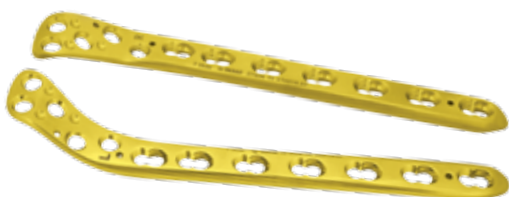

Size : 5 Hole to 13 Hole
Fixation with 5.0 mm Lock. Screw

LOCK. PROXIMAL TIBIA HEAD BUTTRESS PLATE (RAFT PLATE) (LEFT & RIGHT)
CAT No. 1509



Size : 5 Hole to 13 Hole
Fixation with 3.5 mm Lock. Screw

LOCK. PLATE

LOCK. T-BUTTRESS PLATE

CAT No. 1510



Size : 4 Hole to 12 Hole
Fixation with 5.0 mm Lock. Screw

LOCK. EXTRA ARTICULAR VOLAR PLATE (LEFT & RIGHT)

CAT No. 1515

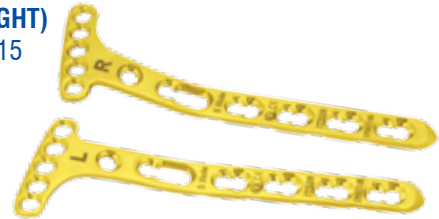

Size : 3 Hole to 5 Hole
Fixation with 2.7 mm Lock. Screw

LOCK. POSTERIOR TIBIA PLATE

CAT No. 1511



Size : 1 Hole to 8 Hole
Fixation with 3.5 mm Lock. Screw

LOCK. CLAVICLE HOOK PLATE (LEFT & RIGHT)

CAT No. 1516



Size : 3 Hole to 6 Hole
Fixation with 3.5 mm Lock. Screw

LOCK. DISTAL FIBULA PLATE

CAT No. 1512

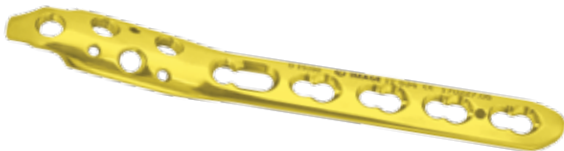

Size : 3 Hole to 10 Hole
Fixation with 3.5 mm Lock. Screw

LOCK. DISTAL HUMERUS PLATE WITH SUPPORT (LEFT & RIGHT)

CAT No. 1517



Size : 3 Hole to 9 Hole
Fixation with 2.7 mm & 3.5 mm Lock. Screw

LOCK. HEAD VOLAR PLATE (LEFT & RIGHT)

CAT No. 1513



Size : 3 Hole to 5 Hole
Fixation with 2.7 mm Lock. Screw

LOCK. DISTAL HUMERUS PLATE WITHOUT SUPPORT (LEFT & RIGHT)

CAT No. 1518

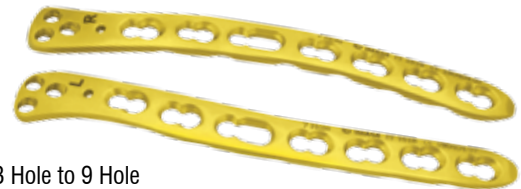

Size : 3 Hole to 9 Hole
Fixation with 2.7 mm & 3.5 mm Lock. Screw

LOCK. T-OBLIQUE VOLAR PLATE (LEFT & RIGHT)

CAT No. 1514



Size : 3 Hole to 5 Hole
Fixation with 2.7 mm Lock. Screw

LOCK. DISTAL HUMERUS PLATE MEDIAL TYPE (LEFT & RIGHT)

CAT No. 1519

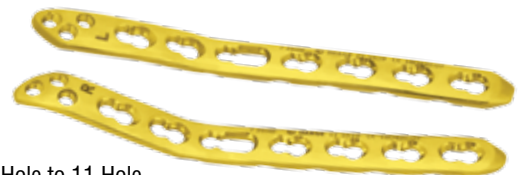

Size : 5 Hole to 11 Hole
Fixation with 2.7 mm & 3.5 mm Lock. Screw

LOCK. PLATE

LOCK. OLECRANON PLATE (LEFT & RIGHT)

CAT No. 1520



Size : 3 Hole to 13 Hole
Fixation with 3.5 mm Lock. Screw

LOCK. T-RADIUS PLATE

CAT No. 1527



Size : 3 Hole to 8 Hole
Fixation with 3.5 mm Lock. Screw

LOCK. ONE THIRD TUBULAR PLATE

CAT No. 1521



Size : 4 Hole to 12 Hole
Fixation with 3.5 mm Lock. Screw

LOCK. T-OBLIQUE PLATE (LEFT & RIGHT)

CAT No. 1528



Size : 3 Hole to 8 Hole
Fixation with 3.5 mm Lock. Screw

LOCK. T-POSTERIOR MEDIAL TIBIA PLATE (LEFT & RIGHT)

CAT No. 1523

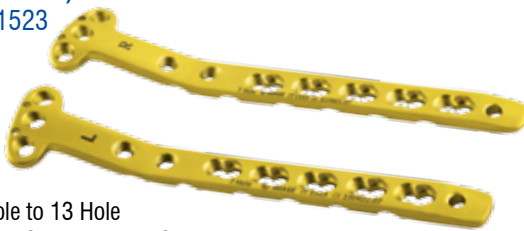

Size : 3 Hole to 13 Hole
Fixation with 3.5 mm Lock. Screw

LOCK. EXTRA ARTICULAR DISTAL HUMERUS PLATE (LEFT & RIGHT)

CAT No. 1529



Size : 5 Hole to 13 Hole
Fixation with 3.5 mm Lock. Screw

LOCK. RECONSTRUCTION PLATE (3.5 mm x COMBI HOLE)

CAT No. 1525



Size : 5 Hole to 12 Hole
Fixation with 3.5 mm Lock. Screw

LOCK. CLAVICLE PLATE (LEFT & RIGHT)

CAT No. 1530

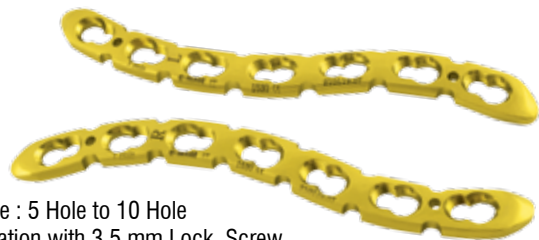

Size : 5 Hole to 10 Hole
Fixation with 3.5 mm Lock. Screw

LOCK. ONE THIRD TUBULAR PLATE (3.5 mm x COMBI HOLE)

CAT No. 1526

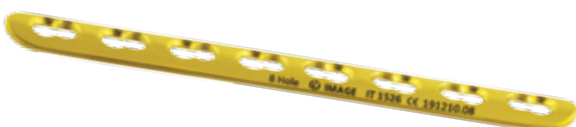

Size : 5 Hole to 12 Hole
Fixation with 3.5 mm Lock. Screw

LOCK. CALCANEUS PLATE (LEFT & RIGHT)

CAT No. 1531

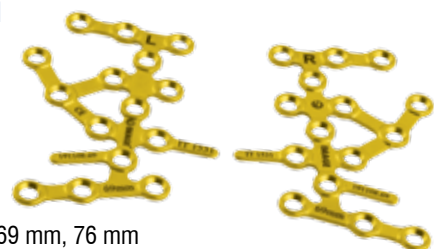

Size : 64 mm, 69 mm, 76 mm
Fixation with 3.5 mm Lock. Screw

LOCK. PLATE

LOCK. DISTAL FEBULA PLATE (2.7 mm)
(LEFT & RIGHT)
CAT No. 1532



Size : 3 Hole to 8 Hole
Fixation with 2.7 mm & 3.5 mm Lock. Screw

LOCK. PROXIMAL FEMUR GT BUTTRESS PLATE
(LEFT & RIGHT)
CAT No. 1534



Size : 2 Hole
Fixation with 5 mm Lock. Screw

LOCK. ANTROLATERAL DISTAL TIBIA PLATE
(LEFT & RIGHT)
CAT No. 1533

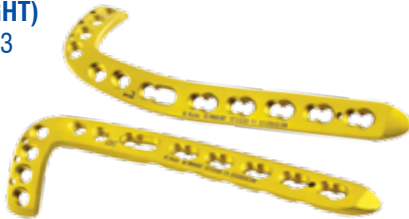

Size : 6 Hole to 8 Hole
Fixation with 3.5 mm Lock. Screw

LOCK. HEAD VOLAR PLATE (VARIABLE)
(LEFT & RIGHT)
CAT No. 1537



Size : 3 Hole to 5 Hole
Fixation with 2.7 mm Lock. Screw

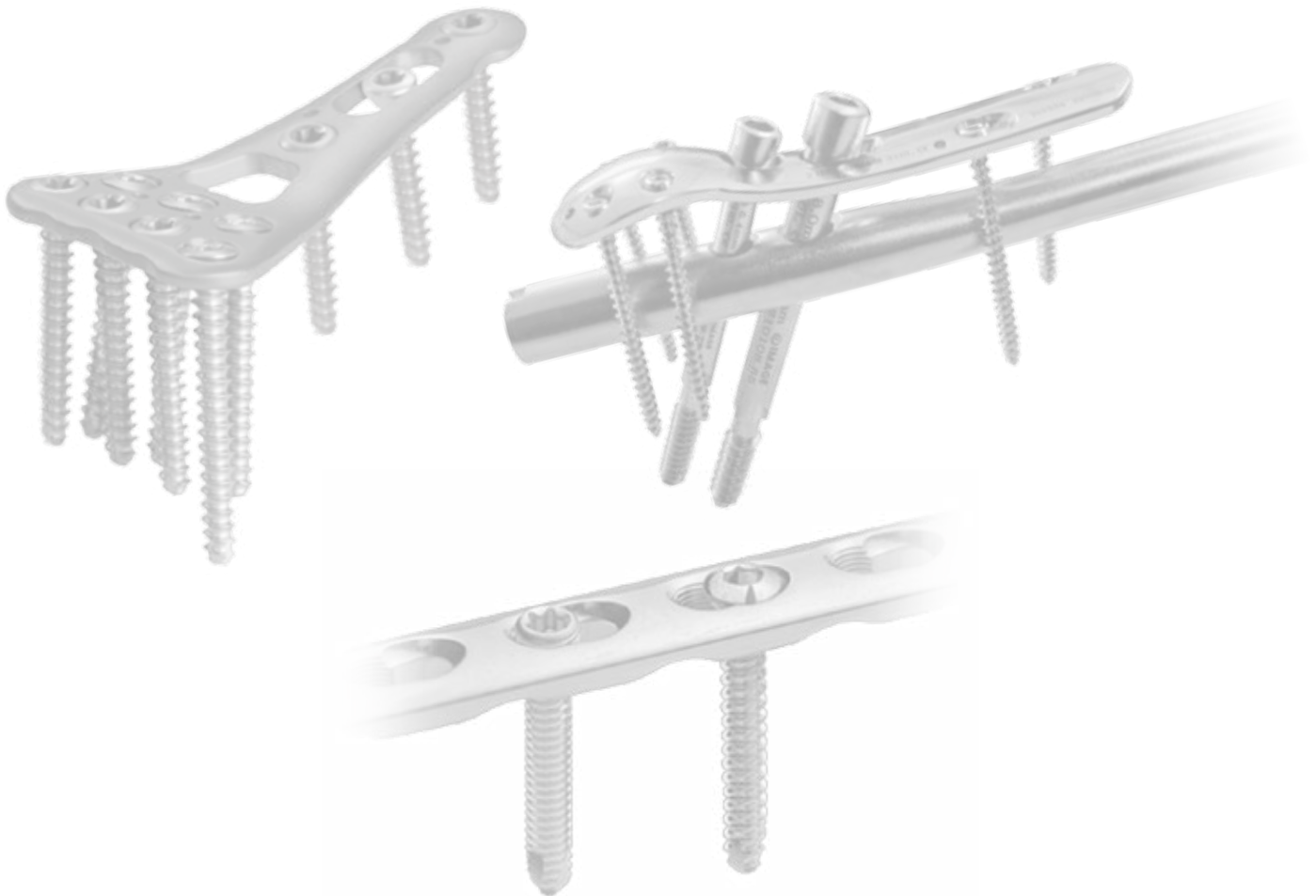

NAIL SYSTEM

INTERLOCKING NAIL (TIBIA)

CAT No. 1601



Size : 8 mm : 28 cm to 38 cm with 2 cm variation
9 mm : 28 cm to 38 cm with 2 cm variation
10 mm : 28 cm to 38 cm with 2 cm variation
11 mm : 28 cm to 38 cm with 2 cm variation

T. F. NAIL

CAT No. 1605



Size : 9 mm, 10 mm, 11 mm, 12 mm
Length : 180 mm

INTERLOCKING NAIL (FEMUR)

CAT No. 1602



Size : 9 mm : 34 cm to 46 cm with 2 cm variation
10 mm : 34 cm to 46 cm with 2 cm variation
11 mm : 34 cm to 46 cm with 2 cm variation
12 mm : 34 cm to 46 cm with 2 cm variation

P. F. NAIL

CAT No. 1606



Size : 9 mm, 10 mm, 11 mm, 12 mm
Length : 250 mm

INTERLOCKING NAIL (HUMERUS)

CAT No. 1603



Size : 6 mm : 18 cm to 30 cm with 2 cm variation (Solid)
7 mm : 18 cm to 30 cm with 2 cm variation (Cannu.)
8 mm : 18 cm to 30 cm with 2 cm variation (Cannu.)

P. F. NAIL (LEFT & RIGHT)

CAT No. 1607



Size : 9 mm : 34 cm to 44 cm with 2 cm variation
10 mm : 34 cm to 44 cm with 2 cm variation
11 mm : 34 cm to 44 cm with 2 cm variation
12 mm : 34 cm to 44 cm with 2 cm variation

A. P. F. NAIL

CAT No. 1604



Size : 9 mm, 10 mm, 11 mm, 12 mm
Length : 180 mm & 240 mm

EXPERT TIBIA NAIL

CAT No. 1608



Size : 8 mm : 28 cm to 38 cm with 2 cm variation
9 mm : 28 cm to 38 cm with 2 cm variation
10 mm : 28 cm to 38 cm with 2 cm variation
11 mm : 28 cm to 38 cm with 2 cm variation

NAIL SYSTEM

A. P. F. NAIL (LEFT & RIGHT)
CAT No. 1609



Size : 9 mm : 34 cm to 44 cm with 2 cm variation
10 mm : 34 cm to 44 cm with 2 cm variation
11 mm : 34 cm to 44 cm with 2 cm variation

RUSH NAIL
CAT No. 1611

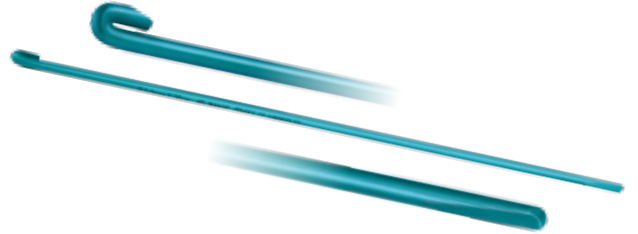

Size : 1.5 mm to 3.5 mm with 0.5 mm variation
Length : 18 cm to 30 cm with 2 cm variation

ELASTIC NAIL
CAT No. 1610

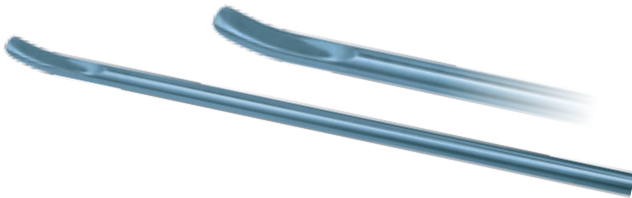

Size : 2 mm to 5 mm with 0.5 mm variation
Length : 44 cm

I. M. S. C. NAIL
CAT No. 1612



Size : 9 mm : 15 cm to 35 cm with 5 cm variation
10 mm : 15 cm to 35 cm with 5 cm variation
11 mm : 15 cm to 35 cm with 5 cm variation
12 mm : 15 cm to 35 cm with 5 cm variation

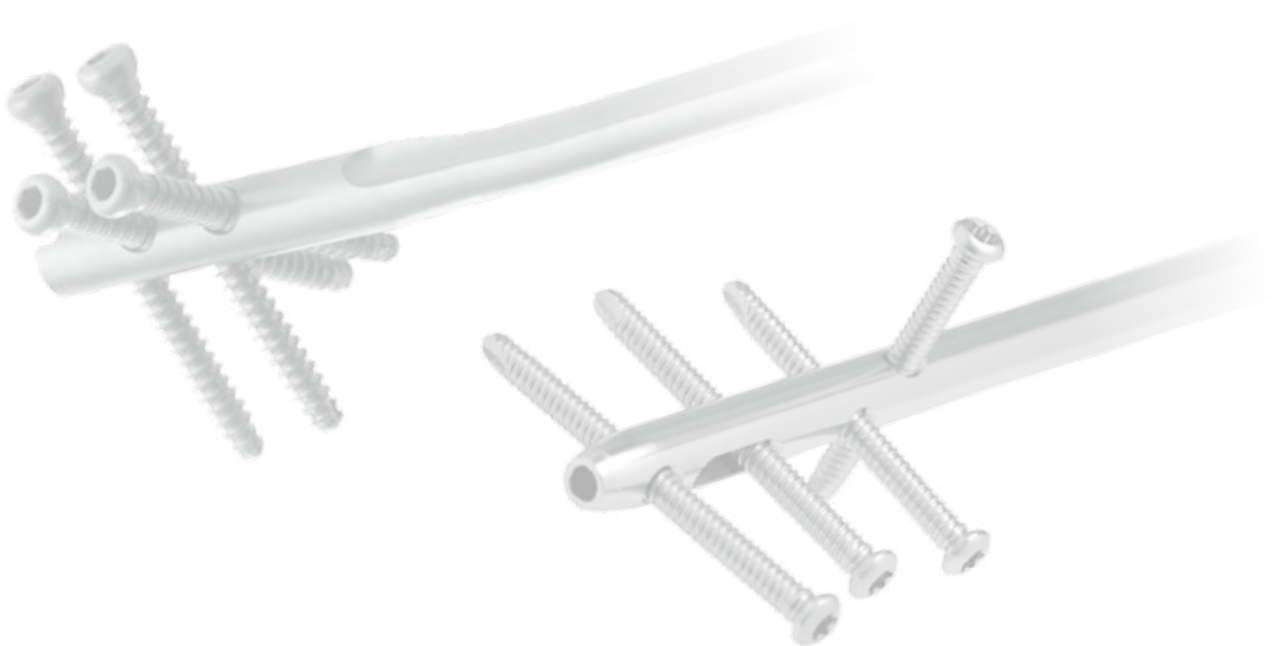



IMAGE[®]

ORTHO. SURGICAL PVT. LTD.

An ISO 13485 Certified Company

3-4/A, Ganesh Estate, B/h. Torrent Power Sub-Station,

Memco - Naroda Road, Memco Cross Road,

Ahmedabad - 380025 (Gujarat) INDIA

Phone : +91-79-2220 2080

Mobile : +91-98251 97942

E-mail : imageortho@rediffmail.com • info@imageorthosurgical.com

Customer Care No.: +91-81289 97942

www.imageorthosurgical.com

F.D.A.
Certified Co.

ISO 13485:2003
Certified

ISO 9001:2008
Certified



Authorised Dealer :



Our products subject to change without prior notice.